

HIOKI

Instruction Manual

FT3405

FT3406

TACHO HiTESTER

HIOKI E. E. CORPORATION

May 2013 Revised edition 2 FT3405A981-02 13-05H



600336572

Contents

Introduction.....	1
Verifying Package Contents	1
Safety Information	2
Operating Precautions	5

Chapter 1 Overview 9

1.1 Product Overview	9
1.2 Features	9
1.3 Names and Functions of Part.....	10

Chapter 2 Preparing for Measurement 17

- Installing or Replacing the Batteries 17
- Connecting the AC Adapter (Option)
(FT3406 only) 19
- Connecting the Contact Adapter
(Option) 20
- Connecting the Instrument to a Tripod 20
- Connecting the Analog Output Cable
(FT3406 only) 21
- Connecting the Pulse Output Cable
(FT3406 only) 23

Chapter 3 Measurement Procedures 25

■ Pre-Operation Inspection	25
3.1 Turning the Power On and Off	26
3.2 Selecting Measurement Functions	27

3.3	Measurement	28
3.4	Precautions in Measurement of High-Rotation Objects	29
Chapter 4 Instrument Functionality		31
<hr/>		
■	Measured Value Hold	31
■	Measured Value Overrun Display	31
■	Averaging Function	31
■	Maximum/Minimum Value Display	32
■	Rotation Detection Display Function ...	32
■	Configuring the Buzzer	33
■	Display Backlight	33
■	Auto Power Save (APS) Function	33
■	Resetting the System	34
■	Battery Warning (Remaining Battery Life Detection)	34
Chapter 5 Specifications		35
<hr/>		
■	Function specifications	35
■	Accuracy	39
■	General specifications	40
Chapter 6 Maintenance and Service		41
<hr/>		
6.1	Cleaning	41
6.2	Consumables	41
6.3	Discarding the Instrument	41
6.4	Troubleshooting	42

Introduction

Thank you for purchasing the HIOKI Model FT3405, FT3406 TACHO HiTESTER. To obtain maximum performance from the instrument, please read this manual first, and keep it handy for future reference.

The "instrument" in this manual means FT3405 and FT3406. Refer to " Options" (⇒ p.14) for details.

Verifying Package Contents

- When you receive the instrument, inspect it carefully to ensure that no damage occurred during shipping. In particular, check the accessories, panel switches, and connectors. If damage is evident, or if it fails to operate according to the specifications, contact your dealer or Hioki representative.
- Use the original packing materials when transporting the instrument, if possible. To avoid damage to the instrument, be sure to remove the Contact Adapter, Contact Tip, Peripheral Ring, Output Cord and AC Adapter before shipping.

Confirm that these contents are provided.

FT3405 or FT3406



Instruction manual
(This document)



9094 Output Cord
(FT3406 only)

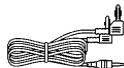

Carrying Case



9211 Reflective Tape



LR6 alkaline battery x2









Safety Information

DANGER

This instrument is designed to comply with IEC 61010 Safety Standards, and has been thoroughly tested for safety prior to shipment. However, mishandling during use could result in injury or death, as well as damage to the instrument. However, using the instrument in a way not described in this manual may negate the provided safety features. Be certain that you understand the instructions and precautions in the manual before use. We disclaim any responsibility for accidents or injuries not resulting directly from instrument defects.

Safety Symbols

This manual contains information and warnings essential for safe operation of the instrument and for maintaining it in safe operating condition. Before using it, be sure to carefully read the following safety precautions.

	<p>In the manual, the  symbol indicates particularly important information that the user should read before using the instrument.</p> <p>The  symbol printed on the instrument indicates that the user should refer to a corresponding topic in the manual (marked with the  symbol) before using the relevant function.</p>
	Indicates DC (Direct Current).
	Indicates AC (Alternating Current).

Symbols for Various Standards

	This symbol indicates that the product conforms to safety regulations set out by the EC Directive.
---	--

Accuracy

We define measurement tolerances in terms of f.s. (full scale), rdg. (reading) and dgt. (digit) values, with the following meanings:

f.s. (maximum display value or scale length)	The maximum displayable value or scale length. This is usually the name of the currently selected range.
rdg. (reading or displayed value)	The value currently being measured and indicated on the measuring instrument.
dgt. (resolution)	The smallest displayable unit on a digital measuring instrument, i.e., the input value that causes the digital display to show a "1" as the least-significant digit.

Operating Precautions



Follow these precautions to ensure safe operation and to obtain the full benefits of the various functions.

Before use

Before using the instrument the first time, verify that it operates normally to ensure that no damage occurred during storage or shipping. If you find any damage, contact your dealer or Hioki representative.

⚠ WARNING

Before using the instrument, make sure that the insulation on the cable is undamaged and that no bare conductors are improperly exposed. Using the instrument in such conditions could cause an electric shock, so contact your dealer or Hioki representative for repair.

Setting up the instrument

- Although this instrument is dust resistant, it is not completely dust- or waterproof. To prevent possible damage, avoid using in dusty or wet environments.
- The protection rating for the enclosure of this device (based on EN60529) is *IP50.

***IP50:**

This indicates the degree of protection provided by the enclosure of the device against use in hazardous locations, entry of solid foreign objects, and the ingress of water.

- 5: Protected against access to hazardous parts with wire measuring 1.0 mm in diameter. Dust-proof type (The penetration of dust cannot be prevented completely, but quantities of dust that may hinder the stated operation of equipment or safety cannot penetrate the enclosure.
- 0: The equipment inside the enclosure is not protected against the harmful effects of water.

Instrument Installation

WARNING

To avoid damage to the instruments and potentially life-threatening hazards, observe the following precautions.

- Use only the specified/supplied Model Z1004 AC Adapter. AC adapter input voltage range is 100 to 240 VAC (with $\pm 10\%$ stability) at 50/60 Hz. To avoid electrical hazards and damage to the instrument, do not apply voltage outside of this range.
- Before turning the instrument on, make sure the supply voltage matches that indicated on the AC adapter. Connection to an improper supply voltage may damage the instrument or AC adapter and present an electrical hazard.

CAUTION

- If the protective functions of the instrument are damaged, either remove it from service or mark it clearly so that others do not use it inadvertently.
- To avoid damage to the instrument, protect it from physical shock when transporting and handling. Be especially careful to avoid physical shock from dropping.
- To avoid breaking the cables, do not bend or pull them.
- For safety reasons, when taking measurements, only use the 9094 Output Cord provided with the instrument (FT3406 only).

Storage temperature and humidity:

-10°C to 50°C (14 to 122°F), 80%RH or less (non-condensating)

Accuracy guarantee for temperature and humidity:

23°C±5°C (73°F±9°F), 80%RH or less (non-condensating)

Avoid the following locations that could cause an accident or damage to the instrument.



Exposed to direct sunlight
Exposed to high temperature



In the presence of corrosive or explosive gases



Exposed to water, oil, other chemicals, or solvents
Exposed to high humidity or condensation



Exposed to strong electromagnetic fields
Near electromagnetic radiators



Subject to vibration



Near induction heating systems
(e.g., high-frequency induction heating systems and IH cooking utensils)

Measurement Precautions

Rotational speed measurement

CAUTION

Always wear protective eyewear as debris from the rotating object may cause injury.

NOTE

- Depending on the material of the object to be measured or method of touching the contact tip, the measurement error may occur.
- Avoid scratching or dirtying the two lenses inside the detector window.

Using the Contact Adapter

DANGER

- Always use the screw to tighten the contact adapter to the main body. If it becomes loose, the instrument may vibrate or be dislocated and become a hazard.
 - Be careful when measuring with the contact adapter because rotation and vibration of the instrument can produce erratic results with either high or low rotation speeds. Hold the main body firmly against the rotator. Do not place the instrument on a tripod when making measurements.
 - When using the contact adapter for measuring, the instrument is subject to vibration, so measurements should be made only below 19,999 r/min or 333 r/s.
 - When using the Contact Adapter, do not mount the instrument on a tripod.
-

Handling contact tips

DANGER

- Verify that the contact tip has been inserted sufficiently into the adapter axis before beginning measurement. Failure to insert the contact tip sufficiently into the adapter axis may cause it to separate from the axis, contact the rotating object, and fly off in the vicinity of the object.
 - If the contact tip is able to come into contact with the rotating object, exercise caution when winding it onto the object.
 - Do not allow rubber contact tips to come into contact with hot measurement targets. Doing so may cause the contact tip to melt.
-

Analog Output Terminals and Pulse Output Terminals

WARNING

To avoid electrical hazards and damage to the instrument, do not apply voltage exceeding the rated maximum to the Analog Output Terminals and Pulse Output Terminals.

Overview

Chapter 1

1.1 Product Overview

This portable, contactless tachometer uses reflected visible-spectrum light to measure the speed of a rotating object to which reflective tape has been affixed. It can also be used as a contact-type tachometer by attaching the Z5003 Contact Adapter.

1.2 Features

◆ Contactless measurement for long detection range

The instrument's ability to detect speed from up to 50 cm distance allows its use in situations where it would be hazardous to approach the object being measured.

◆ Easy-grip design

Easy-to-grip design and light weight make the instrument easy to handle.

◆ LCD with a wide field of vie

The FT3405/3406 features a transmissive FSTN liquid crystal display (LCD), ensuring its readout is easy to read.

◆ Maximum/minimum value hold

Maximum and minimum values are updated continuously so you can verify variations in rotational speed.

◆ Dust-proof design

The FT3405/3406's enclosure delivers IP 50-grade protection, allowing it to be used with confidence and peace of mind in environments characterized by debris (dust, sand, grit, etc.) thrown off by the rotating object.

◆ Drop Proof

The FT3405/3406 can withstand being dropped from a height of 1 m, making it less likely the unit will be damaged.

◆ Analog Output/ Pulse Output (FT3406 only)

The FT3406 can be used in trend management applications by connecting it to a recorder.

1.3 Names and Functions of Part

Front



Grip

Rear



Z5003 Contact Adapter Hole for fixing screw

Battery Cover

Tripod screw hole

Side



Projection surface

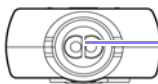

Red light projection/detection window

Base

Model FT3405

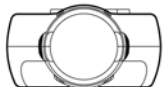

Model FT3406

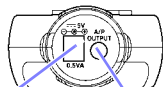

AC adapter connector

Analog/pulse output port

Model FT3406 (shown with cap)



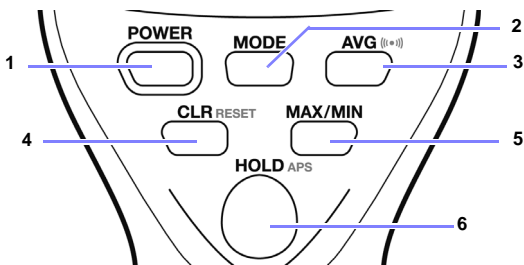

1 POWER	POWER key Turns the instrument on and off.
2 MODE	MODE key Switches the measurement mode (units).
3 AVG	AVERAGE key Switches the sampling time (gate time). Disabled during count measurement.
4 CLR	CLEAR key Clears the current, maximum, minimum, and count values.
5 MAX/MIN	MAX/MIN key Displays the maximum and minimum values. Disabled during count measurement.
6 HOLD	HOLD key Starts and stops updating of measured values. When reflected light is detected, a buzzer sounds and an LED lamp built into the key flashes.

LCD Display



[FT3405 display]

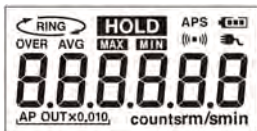

[FT3406 display]

Display	Function	Notes
	Lights up when the buzzer is enabled.	At rotation detection, key operation
APS	Lights up when the Auto Power Save function is enabled.	Turns off when the AC adapter is connected.
	Displays remaining battery life.	Four stages; measurement is stopped when only the outline of the battery remains. Turns off when the AC adapter is connected.
(FT3406 only) 	Turns on when the AC adapter is connected.	Turns off when no power is being supplied from the AC adapter.
HOLD	Lights up when the hold function is active.	
	Lights up when the Contact Adapter is connected.	
	Lights up during circumferential speed measurement.	
MAX	Displays the maximum value obtained since the last time the instrument was reset.	
MIN	Displays the minimum value obtained since the instrument was last reset.	
AVG	Lights up when the averaging function is enabled.	
8.	Displays values.	
OVER	Indicates that the range has been exceeded.	Flashes when the range is exceeded.

rm/smin	Indicates the unit of measurement for rpm measurement, circumferential speed measurement, and period measurement.	Five options: r/s, r/min, m/s, m/min, ms
counts	Indicates the unit of measurement for count measurement.	
(FT3406 only) AP OUT×0.010	Selects pulse output or analog output. When analog output is selected, you can select from x10, x1, x0.1, and x0.01.	Five options: Pout, Aout×10, Aout×1, Aout×0.1, Aout×0.01



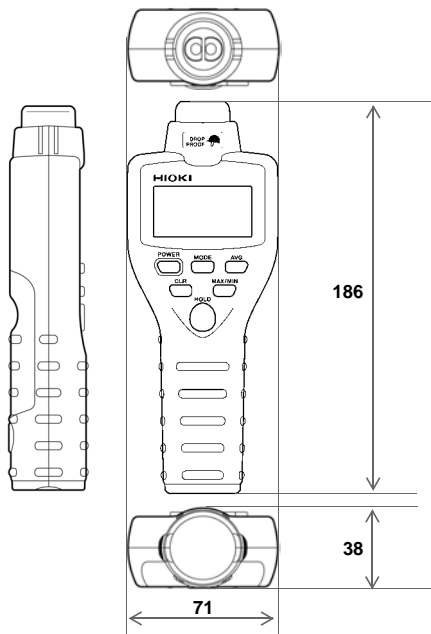

External Dimensions



Unit: mm

Options

The following options are available for the FT3405, FT3406 Tacho Hitester. Ask your dealer or Hioki representative when ordering.

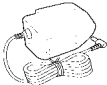
Model, product, and diagram	Notes
Z5003 Contact Adapter 	Dimensions: Approx. 41W×107H×44D mm (1.61"W×4.21"H×1.73"D)(excluding screw) Mass: Approx. 46 g (1.6 oz) *The Z5003 Contact Adapter includes 9032×1, 9033×2, and 9212×1.
9032 Metal Contact Tip 	Attaches to the Z5003 Contact Adapter.
9033 Rubber Contact Tip 	Attaches to the Z5003 Contact Adapter.
9212 Peripheral Ring 	Attaches to the Z5003 Contact Adapter. Outer circumference: 10 cm
Z1004 AC Adapter 	For model FT3406 Rated supply voltage:100 V to 240 V Output voltage: 5 V Output current: 1.2 A Mass: Approx. 69 g (2.4 oz) Plug not included. Dimensions: Approx. 45W×58H×34D mm (1.77"W×2.28"H×1.34"D) Operating temperature and humidity : 0°C to 40°C (32 to 104°F), 20 to 80%RH Storage temperature and humidity : -20°C to 80°C (-4 to 176°F), 10 to 95%RH

Using Z1004 AC Adapter Attachments

The Z1004 AC adapter comes with four plugs. Select and attach the plug that fits the type of outlet used in your area.

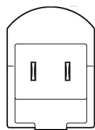

UL type

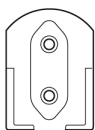

VDE type

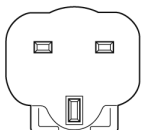

BS type

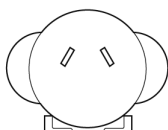

SAA type

Attaching the plug:

Slide the plug into position as shown in the diagram and insert until you hear it click into place.

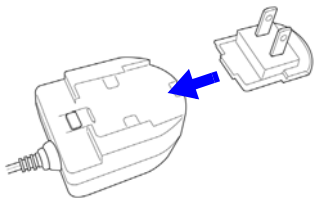

Removing the plug:

Press down firmly on the tab and slide the plug in the direction indicated by the arrow to remove it.

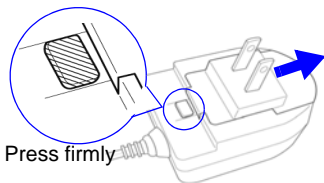

Carrying Case inside structure

Store the instrument as shown below.

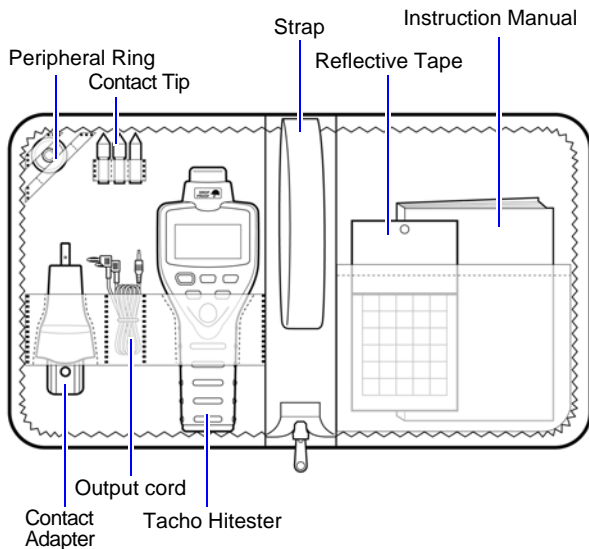

Preparing for Measurement

Chapter 2

Installing or Replacing the Batteries



Install two alkaline batteries (LR6) before using the instrument. Verify that sufficient battery life remains before starting measurement. If the instrument indicates low battery life, replace the batteries.

WARNING

- To avoid electric shock, turn off the power switch and disconnect the AC adapter and output cord before replacing the batteries.
- Do not mix old and new batteries, or different types of batteries. Also, be careful to observe battery polarity during installation. Otherwise, poor performance or damage from battery leakage could result.
- Battery may explode if mistreated. Do not short-circuit, recharge, disassemble or dispose of in fire.
- Handle and dispose of batteries in accordance with local regulations.

CAUTION

- The “” indicator flashes when the remaining battery capacity is low. In this case, the instrument's reliability is not guaranteed. Replace the battery immediately.
- To avoid corrosion and damage to this instrument from battery leakage, remove the batteries from the instrument if it is to be stored for a long time (several months or more).

18 Chapter 2 Preparing for Measurement

1. Turn off the instrument and disconnect the output cord and AC adapter.
2. Remove the screws that secure the battery cover in place on the bottom of the instrument (use a screwdriver).
3. Remove the battery cover.
4. If replacing the batteries, remove the old batteries.
5. Insert two new batteries (LR6), taking care to insert them in the proper orientation.
6. Attach the battery cover and tighten the screws.

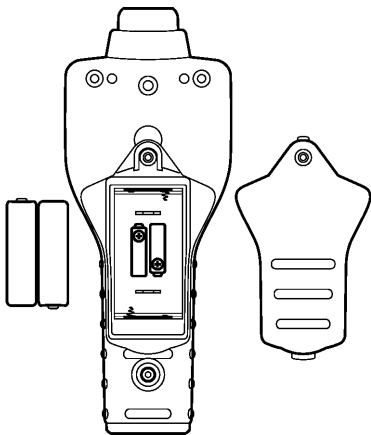

**Connecting the AC Adapter (Option)
(FT3406 only)****!WARNING**

Use only the specified Model Z1004 AC Adapter. AC adapter input voltage range is 100 to 240 VAC (with $\pm 10\%$ stability) at 50/60 Hz. To avoid electrical hazards and damage to the instrument, do not apply voltage outside of this range.

NOTE

- AC adapter output may decrease due to power supply noise, a momentary loss of power, or other factors. To keep the instrument operation from stopping due to these effects when acquiring data for an extended period, it is recommended to use alkaline batteries in the device, even when operating on AC adapter power.
- Make sure the power is turned off before connecting or disconnecting the AC adapter.
- The AC adapter has priority when connected. Consequently, power is not drawn from batteries when the instrument is operating using power supplied from the AC adapter.
- The  indicator is not displayed when no power is being supplied to the AC adapter or when there is a power outage (at this time, the instrument will operate using battery power).

1. Turn off the instrument.
2. Remove the cap on the bottom of the grip and insert the AC adapter jack into the connector.
3. Connect the AC adapter plug to the power supply.
4. Turn on the instrument.
5. The  indicator will be shown on the instrument's display while power is being supplied.

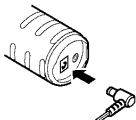
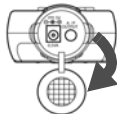

Connecting the Contact Adapter (Option)

To perform contact measurement, attach the Z5003 Contact Adapter.

1. Connect the Contact Adapter as shown in the diagram to the right.
2. Tighten the fixing screw on the bottom of the instrument.
3. Attach the 9032 Metal Contact Tip, 9033 Rubber Contact Tip, and 9212 Peripheral Ring as needed for your application.

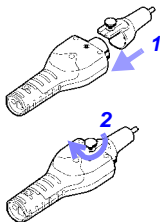

Connecting the Instrument to a Tripod

The instrument can be mounted on a commercially available tripod to perform measurements from an installed (fixed) position. Mount the instrument on the tripod using the tripod screw hole on the bottom of the device.

*Screw size: 1/4 inch

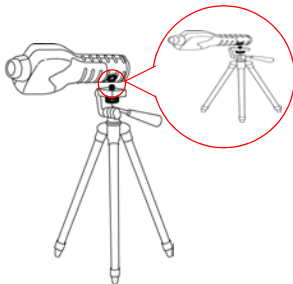

NOTE

- Do not attempt to rotate the instrument to tighten the screw when mounting it on a tripod. Instead, rotate the screw.
- Do not lift or carry the instrument while it is mounted on a tripod.

Connecting the Analog Output Cable (FT3406 only)

NOTE Use only the specified 9094 Output Cord. Using a non-specified cable may result in incorrect measurements due to poor connection or other reasons.

- Electrical specifications
Output resistance: 1 k Ω ; full scale: 1 V; resolution: 1 mV
- Instrument output setting (analog output/pulse output)
Turn off the instrument. Then press the [POWER] key while pressing and holding the [MODE] key to turn it back on. Hold the [MODE] key for no more than 3 seconds and select the desired "Aout__" output port setting from Pout, Aout \times 10, Aout \times 1, Aout \times 0.1, and Aout \times 0.01.
Refer to the following table for more information.

Output is calculated from the display value M as follows

Setting	Measurement mode					
	r/min	r/s	ms	counts	m/min	m/s
Aout \times 10	$M \times 10 / 60$	$M \times 10$	$(1,000/M) \times 10$	r/min output	$M \times 10 / 60 \times 10$	$M \times 10 \times 10$
Aout \times 1	$M \times 1 / 60$	$M \times 1$	$(1,000/M) \times 1$		$M \times 1 / 60 \times 10$	$M \times 1 \times 10$
Aout \times 0.1	$M \times 0.1$	$M \times 0.1 \times 60$	$(1,000/M) \times 0.1 \times 60$		$M \times 0.1 / 60 \times 10$	$M \times 0.1 \times 60 \times 10$
Aout \times 0.01	$M \times 0.01$	$M \times 0.01 \times 60$	$(1,000/M) \times 0.01 \times 60$		$M \times 0.01 / 60 \times 10$	$M \times 0.01 \times 60 \times 10$

(Unit: mV)

- After 3 seconds, the setting will take effect, and the instrument will switch to the selected measurement mode.
- Connection method
 - Remove the cap from the bottom of the instrument.
 - Connect the 9094 Output Cord to the Output port.

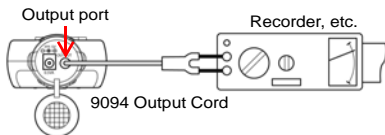

5. Example output waveform

[For averaging on]

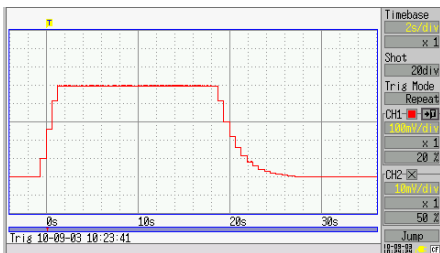

[For averaging off]

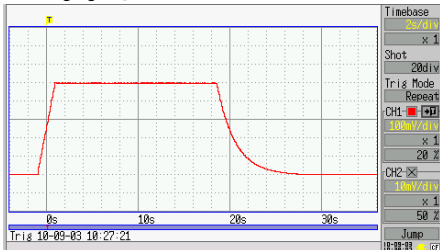
**NOTE**

- At OVER, 1 V is output.
- During hold operation, analog output generates the current value rather than the hold value.

Connecting the Pulse Output Cable (FT3406 only)

1. Function
Outputs pulses detected by the receiver.
2. Electrical specifications
Output resistance: 1 k Ω
Compatible jack diameter: 3.5 mm
Output level: 0 to 3.3 V
(Active low, low level fixed at 300 μ s)
3. Instrument output setting (analog output/pulse output)
Turn off the instrument. Then press the **[POWER]** key while pressing and holding the **[MODE]** key to turn it back on. Hold the **[MODE]** key for no more than 3 seconds and select "Pout" from Pout, Aoutx10, Aoutx1, Aoutx0.1, and Aoutx0.01 as the output port setting.
4. After 3 seconds, the setting will take effect, and the instrument will switch to the selected measurement mode.
5. Connection method
 1. Remove the cap from the bottom of the instrument.
 2. Connect the 9094 Output Cord to the Output port.

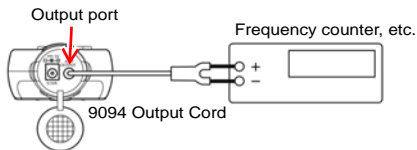

6. Example output waveform

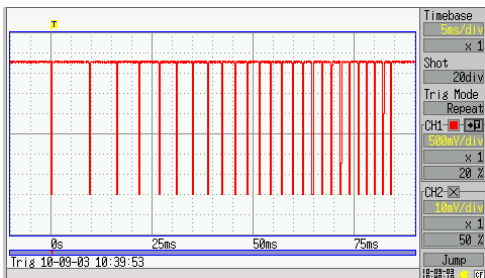

NOTE

- Output is generated under all measurement conditions, regardless of the set function or unit.
- To avoid damage to the instrument, do not apply voltage to output terminals. To avoid damage to the instrument, do not apply voltage to output terminals

Measurement Procedures

Chapter 3

- Before using, be sure to read Safety Information (⇒ p.2), Operating Precautions (⇒ p.5) and Chapter 2 Preparing for Measurement (⇒ p.17).
- Before using the Tester the first time, verify that it operates normally to ensure that no damage occurred during storage or shipping. If you find any damage, contact your dealer or Hioki representative.

Pre-Operation Inspection

Instrument inspection

- Is the insulation of the output cord to be used damaged, or is bare metal exposed?
- Is damage to the instrument evident?
- Is damage to the AC adapter evident? (FT3406 only)

Yes

Do not use the instrument if even one point of damage is found, as it can cause electric shock. Replace the damaged items.

Inspection at power on

<When using batteries>

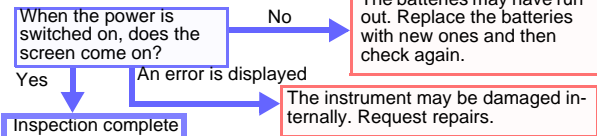

<When using AC adapter FT3406 only>

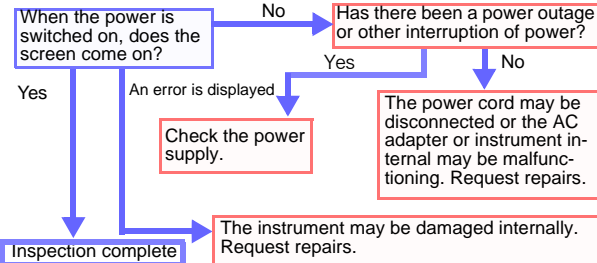

3.1 Turning the Power On and Off

1. Press and hold the **[POWER]** key for at least 1 second to turn on the instrument. All the indicators on the LCD display will turn on briefly, and the instrument will enter measurement mode.

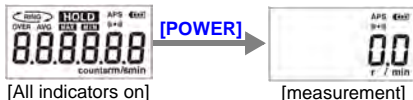

2. To turn off the instrument, press and hold the **[POWER]** key for at least 1 second.
3. Setting and measurement data is treated as follows when the instrument is turned off:

Measured value (last value)	Cleared
Maximum value	Cleared
Minimum value	
Count value	Cleared
Measurement unit setting	Saved
Averaging setting	Saved
Auto Power Save setting	Reverts to "ON"
Buzzer setting	Saved
Output function setting	Saved

NOTE

- Settings are saved when the instrument is turned off. Consequently, if power to the instrument is interrupted without pressing the **[POWER]** key after settings have been changed (for example, by removing the batteries or turning off power to the AC adapter), those settings will not be saved.
- Settings are saved when the instrument is turned off by the Auto Power Save function.

3.2 Selecting Measurement Functions

The unit of display changes each time the [MODE] key is pressed.

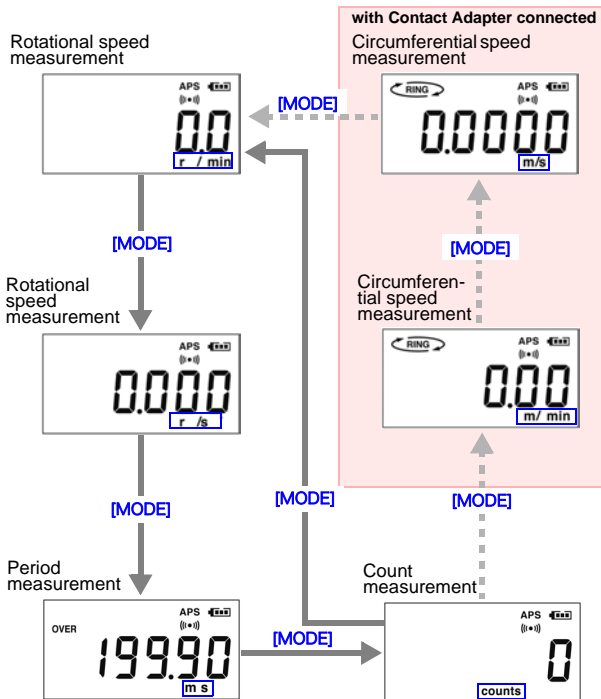

NOTE When selecting circumferential speed measurement, attach the 9212 Peripheral Ring to the Z5003 Contact Adapter.

3.3 Measurement

Measurement Method

1. When performing contactless measurement, reflective tape is applied to the measurement target. Contact measurement is used to measure rotating objects that cannot be stopped since it is impossible to apply reflective tape in such applications. Please note that 19,999 r/min. is the maximum rotational speed that can be measured.
2. If the measured value is being held, press the **[HOLD]** key to cancel the hold function.
3. Orient the instrument so that the red light projector is perpendicular to the reflective tape.
If performing contact measurement, place the contact tip or circumferential speed ring in contact with the measurement target.
4. Hold and read the measured value.

Stopping measured value display updates (⇒ p.31)

Limiting measured value variation (⇒ p.31)

Displaying maximum and minimum values (⇒ p.32)

Stopping the buzzer (⇒ p.33)

Canceling the Auto Power Save function (⇒ p.33)

Resetting the system (⇒ p.34)

Reading the battery life indicator (⇒ p.34)

NOTE

- When using the Contact Adapter, slippage of the apparatus may introduce an error component into readings.
- When using the Contact Adapter, the method with which the apparatus is brought into contact with the measurement target may introduce an error component into readings.

3.4 Precautions in Measurement of High-Rotation Objects

Detection of reflected light uses modulated light to minimize the effects of incident light. When this modulated light is input for a fixed period of time (about 0.2 ms) or longer, a single pulse is detected. For this reason, if the light pulse generated by the passing reflective tape is less than 0.2 ms detection is not possible.

The range that can be detected with a 12 mm square target of reflective tape is indicated below.

*Radius is the distance between the center of the rotating object and the center of the tape.

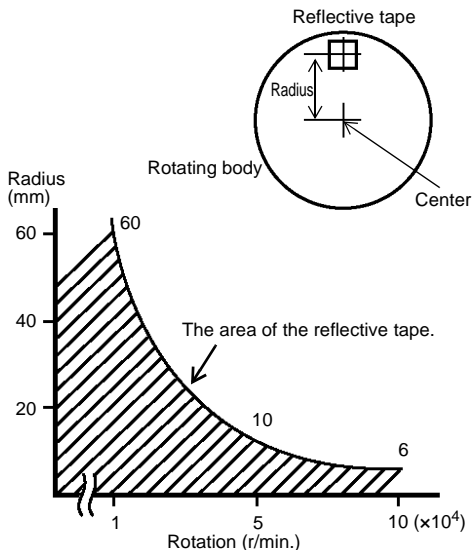

If the reflective tape cannot be attached within this detection range, increase the area of the reflective tape so that the generated pulse is 0.2 ms or higher.

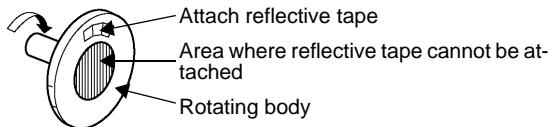

For measurement of 30,000 r/min. or higher, use the following method:

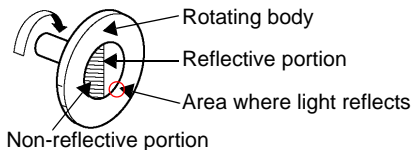

NOTE The red light from the instrument should be adjusted slightly off center as shown, not to the center of the rotating body.

Instrument Functionality

Chapter 4

Measured Value Hold

Stops updating the measured value to allow easy reading.

1. Press **[HOLD]** key once to fix the measured value, preventing updates. The **HOLD** indicator will light up.



2. Press the **[HOLD]** key again to resume display updates.

Measured Value Overrun Display

The **OVER** indicator will flash when the measurement range is exceeded.



Averaging Function

The averaging function is used when measured values exhibit instability. Pressing the **[AVG]** key toggles the averaging function on and off. Activating the averaging function enables the last digit of the display.



Maximum/Minimum Value Display

1. Pressing the [MAX/MIN] key toggles the display as follows:
Current value → Maximum value → Minimum value.
2. Pressing the [CLR] key while displaying the maximum or minimum value clears that value to zero.

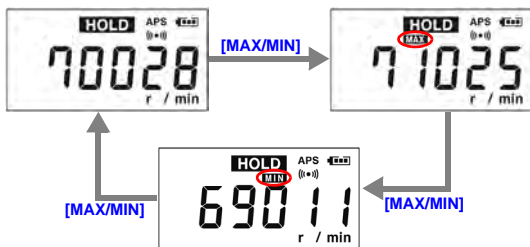

Rotation Detection Display Function

1. When the measurement signal (reflected light signal) is detected, an LED indicator built into the [HOLD] key will flash.
2. The buzzer will sound when the LED indicator flashes.
See "Configuring the Buzzer" (⇒ p.33)



Configuring the Buzzer

The buzzer is configured when turning on the instrument.

Turning off the buzzer:

Turn on the instrument by pressing the **[POWER]** key while holding down the **[AVG]** key to disable the buzzer.

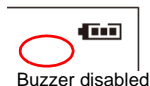

Re-enabling the buzzer:

Turn on the instrument by pressing the **[POWER]** key while holding down the **[AVG]** key again to re-enable the buzzer.



Display Backlight

The display backlight remains on at all times and cannot be turned off.

Auto Power Save (APS) Function

The Auto Power Save function is configured when turning on the instrument.

- The function operates automatically when the instrument is turned on.
- After five minutes of inactivity and no measurement signal detection, the instrument turns off automatically. This function is only operative when using battery power.
- "APS" starts to blink at 30 seconds before turning off.

Disabling Auto Power Save: :

Turn on the instrument by pressing the **[POWER]** key while holding down the **[HOLD]** key to disable Auto Power Save.

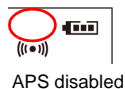

Re-enabling Auto Power Save:

Turn off the instrument and then turn it back on. The APS function will be enabled.

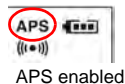

Resetting the System

The system is reset when turning on the system.

Turn on the instrument by pressing the **[POWER]** key while holding down the **[CLR]** key to reset the system.

Reset parameters

Measured value	Cleared
Maximum and minimum values	Cleared
Measurement function	Rotational speed measurement
Measurement unit	r/min
Auto Power Save function	ON
Averaging function	OFF
Buzzer	ON
Output function	Aoutx10

Battery Warning (Remaining Battery Life Detection)

The instrument's remaining battery life is shown at the top right corner of the display.



Remaining battery life indicator	Battery status
	After new alkaline batteries have been loaded
	When 2/3 of the battery life remains
	When 1/3 of the battery life remains
	(Flashing) There is no battery life remaining. When this indicator is displayed, further measurement is not possible. Replace the batteries in the instrument.



NOTE

- Use of manganese batteries will result in a dramatically shorter continuous operating time.
- The remaining battery life indicator will not operate properly when using nickel-metal-hydrate batteries.



Specifications

Chapter 5

Function specifications

Measurement functions	<p>Rotational speed measurement: Rotational speed measurement, period measurement, count measurement</p> <p>Circumferential speed measurement: (when using Z5003 Contact Adapter and 9212 Peripheral Ring)</p>
Measurement method	<p>Visible-spectrum light photoelectric reflection: Using red visible-spectrum light and reflective tape or a reflective plate (Z5003 Contact Adapter)</p> <p>Connection method: Contact or contactless</p> <p>Contactless measurement detection range: 50 to 500 mm (when instrument is oriented perpendicular to reflective tape) (when using 12 mm² reflective tape)</p> <p>Reflection detection indicator: Flashing red LED built into [HOLD] key, buzzer</p> <p>Sampling period: 62.5 ms to 2 s Varies with contact/contactless measurement and averaging setting</p> <p>Display refresh rate: Approx. 0.5 to 10 times/sec</p> <p>Processing at no input: Displays 0 (during period measurement, displays maximum value)</p> <p>Processing at input overrun: Displays [OVER]</p> <p>Range switching: Automatic</p>
Measurement mode switching	<p>Setting method: Repeated [MODE] key input</p> <p>Operation: Unit of measurement changes with repeated key input</p> <p>Without Contact Adapter: Rotational speed (r/min) → Rotational speed (r/s) → Period (ms) → Count (counts)</p> <p>With Contact Adapter: Rotational speed (r/min) → Rotational speed (r/s) → Period (ms) → Count (counts) → Circumferential speed (m/min) ( lights up) → Circumferential speed (m/s) ( lights up)</p>
Averaging function	<p>Setting method: Repeated [AVG] key input</p> <p>Operation: Off → Averaging on with AVG indicator lit</p> <p>Function description: Off: Max. gate time of 0.2 s On: Max. gate time of 2.0 s</p> <p>Default setting: Off</p> <p>*Function does not operate (i.e., is turned off) during count measurement.</p>

Display value hold	<p>Activation method: Updating of measured values is stopped with [HOLD] key input. The HOLD indicator will light up.</p> <p>Deactivation method: Repeated [HOLD] key input</p>
Display of maximum/minimum values	<p>Configuration method: Repeated [MAX/MIN] key input</p> <p>Operation description: Normal value → Maximum value (MAX lights up) → Minimum value (MIN lights up)</p> <p>*This function is not available during count measurement (the key is disabled).</p>
Clearing of measured values	<p>Operation method: [CLR] key input</p> <p>Operation description: The current value, maximum value, minimum value, count measured value, and circumferential speed value are reset to zero.</p> <p>Notes: The measured value is also cleared when switching measurement modes and changing the averaging setting.</p>
APS (Auto Power Save)	<p>Operation description: The instrument turns off after 5 minutes of inactivity and no measurement signal detection.</p> <p>Initial state: On (APS lights up)</p> <p>Deactivation method: Power-on option [HOLD] + [POWER]</p> <p>*APS is automatically disabled when the AC adapter is connected (when a standard voltage is detected).</p>
Buzzer	<p>Operation description: The buzzer sounds for 30 ms each time a rotation is detected.</p> <p>Initial state: On ((•••) lights up)</p> <p>Deactivation method: Power-on option [AVG] + [POWER]</p> <p>*The buzzer also sounds when keys are pressed (this functionality cannot be disabled).</p>
Remaining battery life detection	<p>Operation description: At 1.9 V (± 0.1 V), the remaining battery life is shown as 0, the battery outline flashes, and the measured value display is turned off. At and below 1.8 V (± 0.1 V), the instrument turns off.</p>
Contact Adapter detection	<p>Function description: Attachment of the Contact Adapter is automatically detected.</p> <p>Operation description: When switching measurement modes, the circumferential measurement setting is available.</p>
Power supply input port (FT3406 only)	<p>Application: Z1004 AC adapter connection</p> <p>Output port: 5.5 mm diameter, center positive</p> <p>Max. input voltage: DC ± 5 V ± 0.3 V</p>

AC adapter detection (FT3406 only)	<p>Operation description: The  indicator lights up when voltage is detected.</p> <p>Notes: The  indicator turns off when the detected voltage value is 0 (for example, during a power outage), even if the adapter is connected.</p>																																						
Pulse output (FT3406 only)	<p>Port profile: 3.5 mm diameter, earphone jack type (Shared port; switchable between pulse output and analog output)</p> <p>Output resistance: 1 kΩ Output level: 0 to 3.3 V Output information: Outputs the detection pulse. Active-low output Low output duration: 300 μs</p>																																						
Analog output (FT3406 only)	<p>Output port: 3.5 mm diameter, earphone jack type (shared port; switchable between pulse output and analog output)</p> <p>Output resistance: 1 kΩ Output level: 0 to 1 V f.s. Resolution: 1 mV Response speed: Varies with averaging setting Accuracy: ±2% f.s. Accuracy guarantee temperature and humidity range: 23°C ±5°C, 80% RH or less Outside above temperature range: Add accuracy specifications × 0.1 × (T-23), where T is the operating temperature in Celsius.</p>																																						
Output information: Output is calculated from the display value M as follows																																							
<table border="1"> <thead> <tr> <th rowspan="2">Setting</th> <th colspan="6">Measurement mode</th> </tr> <tr> <th>r/min</th> <th>r/s</th> <th>ms</th> <th>counts</th> <th>m/min</th> <th>m/s</th> </tr> </thead> <tbody> <tr> <td>Aout×10</td> <td>M×10/60</td> <td>M×10</td> <td>(1,000/M)×10</td> <td rowspan="4">r/min output</td> <td>M×10/ 60×10</td> <td>M×10 ×10</td> </tr> <tr> <td>Aout×1</td> <td>M×1/60</td> <td>M×1</td> <td>(1,000/M)×1</td> <td>M×1/ 60×10</td> <td>M×1 ×10</td> </tr> <tr> <td>Aout×0.1</td> <td>M×0.1</td> <td>M×0.1 ×60</td> <td>(1,000/M)×0.1×60</td> <td>M×0.1/ 60×10</td> <td>M×0.1×60 ×10</td> </tr> <tr> <td>Aout×0.01</td> <td>M×0.01</td> <td>M×0.01 ×60</td> <td>(1,000/M)×0.01×60</td> <td>M×0.01/ 60×10</td> <td>M×0.01×60 ×10</td> </tr> </tbody> </table>		Setting	Measurement mode						r/min	r/s	ms	counts	m/min	m/s	Aout×10	M×10/60	M×10	(1,000/M)×10	r/min output	M×10/ 60×10	M×10 ×10	Aout×1	M×1/60	M×1	(1,000/M)×1	M×1/ 60×10	M×1 ×10	Aout×0.1	M×0.1	M×0.1 ×60	(1,000/M)×0.1×60	M×0.1/ 60×10	M×0.1×60 ×10	Aout×0.01	M×0.01	M×0.01 ×60	(1,000/M)×0.01×60	M×0.01/ 60×10	M×0.01×60 ×10
Setting	Measurement mode																																						
	r/min	r/s	ms	counts	m/min	m/s																																	
Aout×10	M×10/60	M×10	(1,000/M)×10	r/min output	M×10/ 60×10	M×10 ×10																																	
Aout×1	M×1/60	M×1	(1,000/M)×1		M×1/ 60×10	M×1 ×10																																	
Aout×0.1	M×0.1	M×0.1 ×60	(1,000/M)×0.1×60		M×0.1/ 60×10	M×0.1×60 ×10																																	
Aout×0.01	M×0.01	M×0.01 ×60	(1,000/M)×0.01×60		M×0.01/ 60×10	M×0.01×60 ×10																																	
(Unit:mV)																																							
Output port setting (FT3406 only)	<p>Configuration method: Power-on option [MODE] + [POWER], then [MODE] key input to cycle Aout×10 → Aout×1 → Aout×0.1 → Aout×0.01 → Pout Setting takes effect after 3 seconds of inactivity. Initial setting: Aout×10</p>																																						

Instrument operation	Assigned function	Regular function	Power-on option
	[POWER]	Power switch	----
	[MODE]	Measurement mode switching	Output port setting (FT3406 only)
	[AVG]	Averaging function setting	Buzzer setting
	[MAX/MIN]	Maximum and minimum value display	----
	[CLR]	Value clear	System reset
	[HOLD]	Hold/cancel measured value	APS setting
Display	Transmissive LCD: FSTN Backlight: Always on		

Ranges and measurement ranges

Note 1: The lowermost digit is fixed at 0 at speeds of 20,000 r/min and over.

Note 2: The lowermost digit is fixed at 0 when the averaging setting is off.

(1) Rotational speed measurement

MODE	Range	Contactless measurement		Contact measurement	
		AVG=ON	AVG=OFF	AVG=ON	AVG=OFF
Rotational speed measurement (r/min)	1	30.00 to 199.99	--	15.00 to 199.99	--
	2	200.0 to 1999.9	300.0 to 1999.0	200.0 to 1999.9	150.0 to 1999.0
	3	2000 to 19999	2000 to 19990	2000 to 19999	2000 to 19990
	4	20000 to 99990	20000 to 99990	--	--
Rotational speed measurement (r/s)	1	0.5000 to 1.9999	--	0.2500 to 1.9999	--
	2	2.000 to 19.999	5.000 to 19.990	2.000 to 19.999	2.500 to 19.990
	3	20.00 to 199.99	20.00 to 199.90	20.00 to 199.99	20.00 to 199.90
	4	200.0 to 1600.0	200.0 to 1600.0	200.0 to 333.0	200.0 to 333.0

Period measurement (ms)	1	0.6000 to 1.9999	0.6000 to 1.9990	--	--
	2	2.000 to 19.999	2.000 to 19.990	3.000 to 19.999	3.000 to 19.990
	3	20.00 to 199.99	20.00 to 199.90	20.00 to 199.99	20.00 to 199.90
	4	200.0 to 1999.9	--	200.0 to 3999.9	200.0 to 399.0
Count measurement (count)	1	0 to 999999 (Input conditions: Up to rotational speed measurement upper limit)			

(2) Circumferential speed measurement

MODE	Range	Contact measurement	
		AVG=ON	AVG=OFF
Circumferential speed measurement (m/min)	1	1.500 to 19.999	--
	2	20.00 to 199.99	15.00 to 199.90
	3	200.0 to 1999.9	200.0 to 1999.0
Circumferential speed measurement (m/s)	1	0.0250 to 1.9999	0.2500 to 1.9990
	2	2.000 to 19.999	2.000 to 19.990
	3	20.00 to 33.30	20.00 to 33.30

Accuracy (Not applicable to count measurement)

	AVG=ON	AVG=OFF
Up to 9,999 counts	±1dgt.	±10dgt.
10,000 counts or more	±2dgt.	±20dgt.
20,000 counts or more (r/min mode only)	±20dgt.	±100dgt.
Period measurement only	±0.5%rdg. is added to above-mentioned accuracy.	

General specifications

Guaranteed accuracy period	1 year
Operating temperature	0 to 50°C (32 to 122°F)
Operating humidity	Up to 40°C (104°F) 80%RH or less 40°C to 45°C (104 to 113°F) 60%RH or less 45°C to 50°C (113 to 122°F) 50%RH or less (non-condensing)
Storage temperature and humidity	-10°C to 50°C (14 to 122,°F) 80%RH or less (non-condensing)
Operating environment	Indoors, Pollution degree 2, altitude up to 2000 m (6562-ft.)
Drop proof	1 m onto concrete surface
Power supply	5 VDC or LR6 alkaline battery x 2
Rated supply voltage	Battery power 1.5 V DC x 2 AC adapter 5 V DC ±0.3 V
Maximum rated power	0.5 VA
Continuous operating time	FT3405: Approx. 30 hours FT3406: Approx. 25 hours *When using alkaline batteries with buzzer off.
Dimensions (max.)	Approx. 71(W)×186(h) × 38(D)mm (2.80"W × 7.32"H × 1.50"D)
Mass	Approx. 230g (8.1 oz) (Including battery)
Dust resistance	IP50 (EN60529)
Applicable Standards	EMC :EN61326 EN61000-3-2 EN61000-3-3 Safety :EN61010
Accessory	Instruction manual 1 9211 Reflective Tape 1 9094 Output Cord (FT3406 only) 1 Carrying Case 1 LR6 alkaline battery 2
Option	Z5003 Contact Adapter 9032 Metal Contact Tip 9033 Rubber Contact Tip 9212 Peripheral Ring Z1004 AC Adapter (FT3406 only) 9094 Output Cord (FT3406 only) 9211 Reflective Tape

Maintenance and Service

Chapter 6

6.1 Cleaning

- To clean the instrument, wipe it gently with a soft cloth moistened with water or mild detergent. Never use solvents such as benzene, alcohol, acetone, ether, ketones, thinners or gasoline, as they can deform and discolor the case.
- Wipe the Lens and LCD gently with a soft, dry cloth.

6.2 Consumables

Replaceable Parts and Operating Lifetimes.

Useful life depends on the operating environment and frequency of use. Operation cannot be guaranteed beyond the following periods. For replacement parts, contact your dealer or Hioki representative.

Part	Operating lifetime
Measurement visible-spectrum red LED and sensor	8,000 hours (about 3 years at 8 hours of use per day) A reduction in detection range indicates the operating lifetime is almost over. The instrument should be repaired.
LCD backlight	50,000 hours If the display becomes difficult to see (dim), the instrument should be repaired.
Batteries	Operating lifetime varies with conditions of use. When the remaining battery life indicator is displayed as  , replace the batteries with new batteries.?

6.3 Discarding the Instrument

WARNING

- Battery may explode if mistreated. Do not short-circuit, recharge, disassemble or dispose of in fire.
- Handle and dispose of batteries in accordance with local regulations.

6.4 Troubleshooting

If damage is suspected, check the “Before returning for repair” before contacting your dealer or Hioki representative.

Before returning for repair:

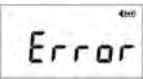
Symptom	Checks and Remedy
Although you have turned on the power switch, the screen display does not appear.	Have the batteries been inserted in the proper orientation? (⇒ p.17)
	Are the batteries correctly inserted? Insert the new batteries.(⇒ p.17)
	Has the AC adapter been connected properly? (FT3406 only) (⇒ p.19)
The instrument turns off.	Is the battery dead? → Replace the battery.(⇒ p.17)
	Is the auto power save function being activated? → Check the auto power save setting. (⇒ p.33)
	AC adapter output may decrease due to power supply noise, a momentary loss of power, or other factors, causing the instrument to switch to battery power. If no batteries are loaded in the instrument, it will turn off. ⇒Keep fresh batteries in the instrument.
 is lit up.	The RING setting cannot be activated without first attaching the Contact Adapter.
The detection range for contactless measurement is low.	The sensor's characteristics vary with temperature. As the ambient temperature increases, the detection range will shorten. This does not indicate an instrument malfunction.
	This message indicates an internal instrument malfunction. The instrument should be repaired.

Pack the instrument so that it will not sustain damage during shipping, and include a description of existing damage. We do not take any responsibility for damage incurred during shipping.

- For regional contact information, please go to our website at <http://www.hioki.com>.
- The Declaration of Conformity for instruments that comply to CE mark requirements may be downloaded from the Hioki website.
- All reasonable care has been taken in the production of this manual, but if you find any points which are unclear or in error, please contact your supplier or the International Sales and Marketing Department at Hioki headquarters.
- In the interests of product development, the contents of this manual are subject to revision without prior notice.
- The content of this manual is protected by copyright.
No reproduction, duplication or modification of the content is permitted without the authorization of Hioki E.E. Corporation.

HIOKI

HIOKI E. E. CORPORATION

Headquarters

81 Koizumi, Ueda, Nagano 386-1192, Japan
TEL +81-268-28-0562 FAX +81-268-28-0568
E-mail: os-com@hioki.co.jp

URL <http://www.hioki.com/>

(International Sales and Marketing Department)

HIOKI USA CORPORATION

E-mail: hioki@hiokiusa.com URL <http://www.hiokiusa.com>

HIOKI (Shanghai) Sales & Trading Co., Ltd.

E-mail: info@hioki.com.cn URL <http://www.hioki.cn>

HIOKI INDIA PRIVATE LIMITED

E-mail: hioki@hioki.in URL <http://www.hioki.in>

HIOKI SINGAPORE PTE. LTD.

E-mail: info@hioki.com.sg

1305